

SMARTWATCH

Smartwatch 8900

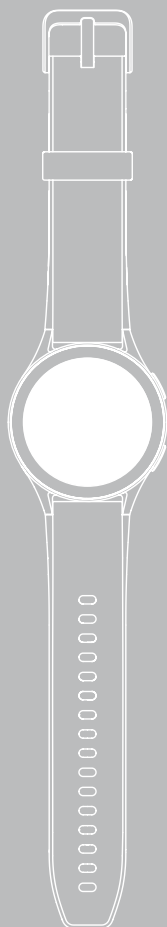

GB Operating Instructions





1. Explanation of warning symbols and notes	5
2. Package contents	5
3. Safety instructions	6
4. Control elements	8
5. Getting started	9
5.1 Charging	9
5.2 Putting on and switching on	10
5.3 Switching off	10
6. Setting up the smartwatch	11
6.1 Downloading the "Hama FIT move" app	11
6.2 Pairing the smartwatch and smartphone	12
7. Operating the smartwatch	14
7.1 Home screen	16
7.2 Notifications	16
7.3 Quick-access settings	17
7.3.1 Do Not Disturb mode	17
7.3.2 Display brightness	17
7.3.3 Wake screen	17
7.3.4 Torch	17
7.3.5 Drainage	17
7.3.6 Alarm clock	17
7.3.7 Energy-save mode	17
7.3.8 Telephone search	17
7.3.9 Settings	17
7.4 Shortcuts	18
7.5 Workout (sport modes)	18
7.5.1 Defining workouts (sport modes) for display	18
7.6 Applications	19
7.6.1 Activity	19
7.6.2 Workout status	19
7.6.3 Running courses	19
7.6.4 Workout (sport modes)	19
7.6.5 Workout record	20
7.6.6 Push for measurement	20
7.6.7 Heart rate	20
7.6.8 Blood oxygen (SpO2)	20
7.6.9 Stress	20
7.6.10 Body energy	20
7.6.11 Sleep	20
7.6.12 Breath training	21
7.6.13 Cycle report	21
7.6.14 Ambient sound	21
7.6.15 Phone	21
7.6.16 Alexa	22
7.6.17 Barometer	22
7.6.18 Compass	22



7.6.19 Pomodoro technique	22
7.6.20 Event reminder	22
7.6.21 Weather	23
7.6.22 Music	23
7.6.23 Camera	23
7.6.24 Alarm clock	23
7.6.25 Timer	23
7.6.26 Stopwatch	23
7.6.27 World clock	23
7.6.28 Telephone search	23
8. Smartwatch settings	24
8.1 Watch faces	24
8.2 AOD settings	24
8.3 Sound and vibration	24
8.4 Display and brightness	24
8.5 App view	24
8.6 DND (Do Not Disturb)	25
8.7 Connect more	25
8.8 System	25
8.9 About	25
9. Using the "Hama FIT move" app	26
9.1 "Hama FIT move" overview	26
9.1.1 Workout data	27
9.1.2 Step measurement	28
9.1.3 Activity records	29
9.1.4 Sleep analysis	30
9.1.5 Heart rate measurement	31
9.1.6 Stress measurement	32
9.1.7 Blood oxygen (SpO2)	33
9.1.8 Ambient sound level	34
9.1.9 Weight	35
9.1.10 VO2max	36
9.1.11 Heart rate variability (HRV)	36
9.1.12 Body energy	36
9.1.13 Menstrual period	37
9.2 Training mode	38
9.2.1 Start an activity (with GPS)	39
9.2.2 Start an activity (without GPS)	41
9.3 Device settings	43
9.3.1 Home screen	44
9.3.2 Notifications	44
9.3.3 Calls	44
9.3.4 Alarm clock	44
9.3.5 Health monitoring	45
9.3.5.1 Body energy	45
9.3.5.2 Heart rate measurement	45
9.3.5.3 Stress measurement	45



9.3.5.4 Blood oxygen measurement	45
9.3.5.5 Drink reminder	45
9.3.5.6 Exercise reminder	45
9.3.5.7 Ambient sound level	46
9.3.5.8 Tracking the menstrual period	46
9.3.6 Event reminder	47
9.3.7 Alexa voice control	48
9.3.8 Other settings	49
9.3.8.1 Automatic activity detection	49
9.3.8.2 Type of activity	49
9.3.8.3 Telephone search	50
9.3.8.4 Music control	50
9.3.8.5 Arm movement activation	50
9.3.8.6 Menstrual period	50
9.3.8.7 Weather notification	50
9.3.8.8 World clock	50
9.3.8.9 Screen brightness	50
9.3.8.10 Shortcuts	51
9.3.8.11 Smartwatch language setting	51
9.3.9 How to use	51
9.4 User settings	52
9.4.1 Personal data	53
9.4.2 My medals	54
9.4.3 My data	54
9.4.4 Health report	55
9.4.5 Messages	55
9.4.6 Settings	56
9.4.7 Help	57
9.4.8 Questions and suggestions	57
9.4.9 Keeping the app running in the background	57
9.4.10 Check for updates	57
9.4.11 About	57
10. Maintenance and care	58
11. Legal disclaimer	58
12. Languages supported	58
13. Technical data	58
14. Information on disposal	59
15. Declaration of conformity	59

EXPLANATION OF WARNING SYMBOLS AND NOTES

We are delighted that you have chosen a Hama product.

Take your time and read the following instructions and information completely. Please keep these instructions in a safe place for future reference.

Your new smartwatch is your ideal companion for a healthy lifestyle and motivates you to stay active all day long. As well as displaying the time and date, it collects data on the number of steps you have taken, your heart rate and the calories you have burned. It establishes a wireless connection to your smartphone via *Bluetooth*® enabling you to document the data on the associated "Hama FIT move" app and, thus, constantly keep track of your success. Use it to check when you have reached your personal fitness goal!

1. Explanation of warning symbols and notes

Warning



This symbol is used to indicate safety instructions or to draw your attention to specific hazards and risks.

Note



This symbol is used to indicate additional information or important notes.

2. Package contents

- "Smartwatch 8900" smartwatch
- 1 USB charging cable
- Operating instructions

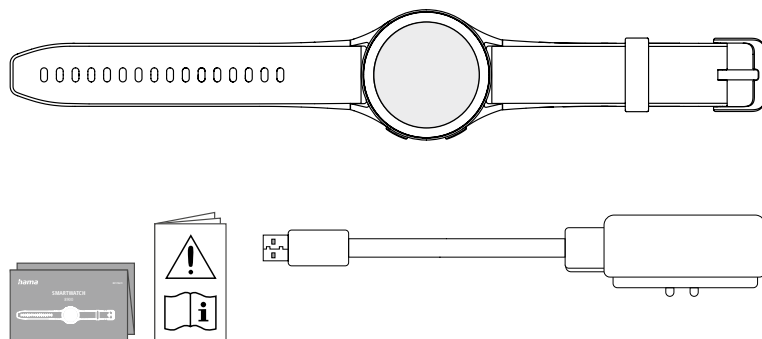

Note



The illustrations provided in these operating instructions correspond to the Smartwatch 8900 model with the article number 00178611. Other models (00178612, 00178613) deviate with regard to appearance. The descriptions of the functions, however, are identical for all models.





3. Safety instructions

Warning



Take your time and read the following instructions and information completely. Information on using the product is provided in this operating instruction manual.

- This product is intended for private, non-commercial use only.
- Use the product only for the intended purpose.
- Protect the product from dirt, moisture and overheating and use it in dry environments only.
- Do not use the product in the immediate vicinity of heaters, other heat sources or in direct sunlight.
- Do not operate the product outside the power limits given in the specifications.
- Do not use the product in areas in which electronic products are not permitted.
- The battery is integrated and cannot be removed.
- Do not open the device or continue to operate it if it becomes damaged.
- Do not attempt to service or repair the product yourself. Have all service work completed by qualified experts.
- Do not drop the product and do not expose it to any major shocks.
- Do not modify the product in any way. Doing so voids the warranty.
- Dispose of packaging material immediately in accordance with the locally applicable regulations.
- Do not incinerate the battery or the product.
- Do not tamper with or damage/heat/disassemble the batteries/rechargeable batteries.
- While driving a car or using sports equipment, do not allow yourself to be distracted by your product and keep an eye on the traffic situation and your surroundings.
- Consult your doctor before starting an exercise programme.
- Always be aware of your body's response when you exercise, and speak to your doctor in an emergency.
- Consult your doctor if you have a medical condition and wish to use the product.
- This is a consumer product, not a medical device. Hence, it is not intended for the diagnosis, therapy, cure or prevention of illnesses.
- Prolonged contact with the skin can lead to skin irritations and allergies. Consult a doctor if symptoms persist.
- This product is not a toy. It contains small parts which could be swallowed and pose a suffocation hazard.
- Only use the article under moderate climatic conditions.



Risk of electric shock



- Do not open the device or continue to operate it if it becomes damaged.
- Do not use the product if the AC adapter, adapter cable or power cable is damaged.
- Do not attempt to service or repair the product yourself. Have all service work completed by the skilled personnel responsible.

Warning - cardiac pacemakers



This product generates magnetic fields. Persons with a cardiac pacemaker should consult a doctor before using this product, as the pacemaker's proper function could be affected.

Information - air traffic



- This product is a constant transmitter of radio signals. Please note that carrying and using radio transmitters during certain phases of the flight (e.g. take-off / landing) is not permitted for safety reasons.
- Check with your airline before you fly whether your fitness tracker can be taken on board. If in doubt, leave the product at home.

Warning - rechargeable battery



- Only use suitable charging devices or USB ports to charge the product.
- Do not use defective chargers or USB ports and do not attempt to repair them.
- Do not overcharge the product or allow the battery to completely discharge.
- Avoid storing, charging and using the product in extreme temperatures and at extremely low atmospheric pressures (such as at high altitudes).
- When in storage over a long period of time, batteries should be charged regularly (at least every three months).



4. Control elements

1. Top control button (Menu)
2. Bottom control button (Workout)
3. Full-touch display
4. Removable watchstrap
5. Fastener
6. Charging contact

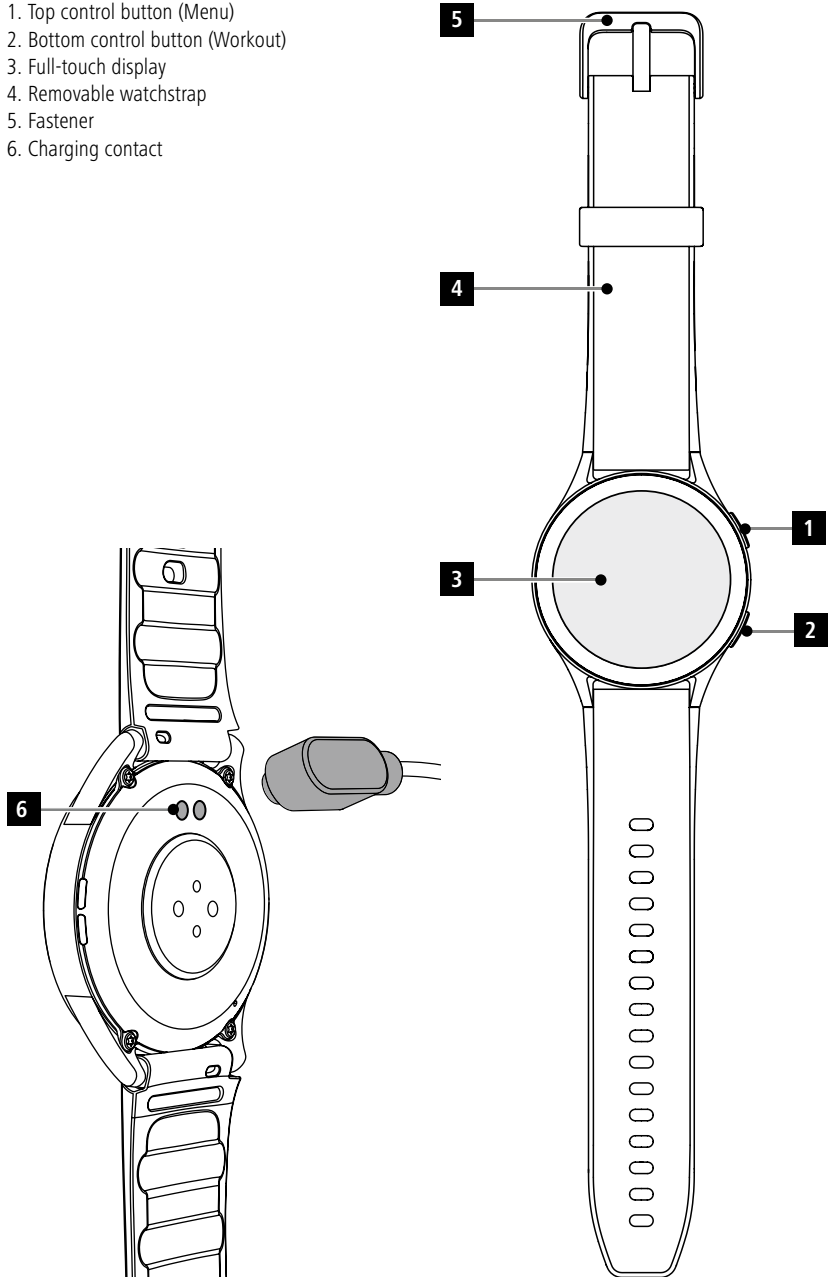



5. Getting started

Note



The descriptions and illustrations in these operating instructions are based on using the **Hama FIT move** app version 1.4.0 and the smartwatch firmware version 1.01.00. Please note that updates to the app or smartwatch could lead to deviations from the names and illustrations used.

5.1 Charging

- Charge your smartwatch fully before using it for the first time.
- Connect the charging cable to a free USB port on your computer or a USB charger and the charging contact **[6]** on your smartwatch. To do this, observe the operating instructions for the USB charger you are using.

Note



- The charging time for a full battery charge is around 150 minutes. When the battery in the display is indicated as being fully charged, the charging process is complete and you can disconnect your smartwatch from the charging cable.
- When the battery charge level drops to just 10%, charge the smartwatch to prevent functional restrictions. When the battery level is below 20%, you can no longer start an activity, and when the battery level is below 10%, the automatic heart rate measurement function is deactivated.



5.2 Putting on and switching on

- Before wearing and switching on the smartwatch for the first time, you must connect it with the enclosed charging cable and plug it into a power source.
- When charging has been completed successfully, apply the smartwatch to your wrist and close the watchstrap [4] using the fastener [5].
- Press and hold the top control button [1] for 3 seconds to start the smartwatch.

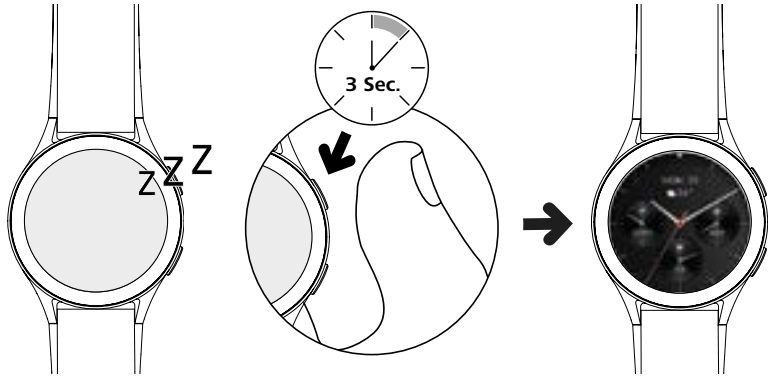



Note



- To be able to use the measuring functions most effectively, it is preferable to fit the smartwatch fairly tightly but comfortably on the top side of the forearm. The distance between smartwatch and the wristbone should be about one finger breadth.
- To ensure the best possible recording of your activities, wear the smartwatch on your left wrist if you are right-handed and on your right wrist if you are left-handed.

5.3 Switching off

- To switch the smartwatch off, open the [SETTINGS ] menu option (see Chapter 7.3.9 Settings) and tap on [TURN OFF ] in the [SYSTEM ] submenu. Confirm the subsequent prompt to switch off the smartwatch.
- Alternatively, press and hold the bottom control button [2] and tap on the [] symbol.



6. Setting up the smartwatch

In order to have access to the full range of functions provided by the smartwatch, you must install the "Hama FIT move" app. The following sections contain information on downloading and setting up the app.

6.1 Downloading the "Hama FIT move" app

Note



The following operating systems are supported:

- iOS 9.0 or higher
- Android 6.0 or higher

After switching on the smartwatch for the first time, you will be prompted to download the corresponding "Hama FIT move" app on your smartphone. A corresponding QR code appears in the display of the smartwatch.

- Scan the QR code with your smartphone or download the app from the Play Store (Android) or the App Store (iOS):



Hama FIT move

link.hama.com/app/fit-move

- To install the app, follow the instructions on your smartphone.



6.2 Pairing the smartwatch and smartphone

Note



- In order for the smartwatch to display incoming calls, text messages, WhatsApp messages and other notifications, activate push mode for messages in your smartphone settings.
- While setting up the app, you will be asked whether the app has permission to access the functions of your terminal device. Agree to these prompts for the full functionality of your smartwatch.
- Start the app on your smartphone and agree to the privacy agreement. Answer any questions that may be asked.

For an optimal user experience, you should create a user account. By creating a user account, you can access your personal data if you change smartphones. This means that your personal data is available at all times. However, creating a user account is not a prerequisite for using the app.

- To create a user account, tap on **[LOG IN]** and select **[REGISTER NOW]** at the bottom edge of the screen. Enter an email address and a password and then tap on **[NEXT STEP]**.
 - Enter the verification code which is sent to you according to the email address specified. It may be necessary to check your Spam folder.
 - When registration has been completed successfully, you can enter a user name, your personal data and assign a profile picture. Please tap on **[NEXT STEP]** to continue the set-up process.
 - The search for your "Smartwatch 8900" smartwatch then begins.
 - Follow the instructions in the app on your smartphone to connect your smartwatch.
- Your smartphone will establish a Bluetooth connection to your smartwatch.

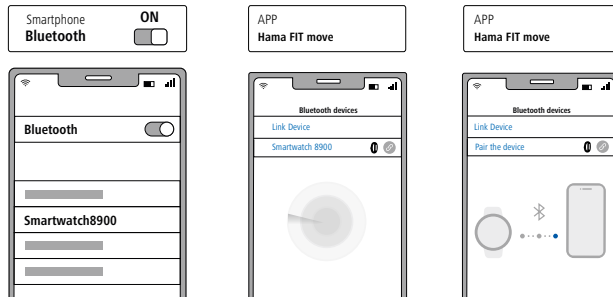

- Select "Watch8900" and tap on **[PAIR THE DEVICE]** to connect the smartwatch to the app.
- Tap on the  symbol in the app on the smartphone to confirm the connection and conclude setting up the app.
- If there is a timeout, repeat the process.



- Then define your personal settings. These can be adapted in the app later (see Chapter **9.4 User settings**).
- Your smartwatch is now linked with the app and synchronisation begins.

Note



- Please synchronise your smartwatch with the app before using it for the first time. If you record an activity before your smartwatch has been synchronised with the app for the first time, the activity will not be transferred to the app afterwards.
- To manually start a synchronisation of the smartwatch with the app, drag the screen downwards on the app home page.
- Due to the limited storage space on the smartwatch, you should synchronise your smartwatch with the app regularly (at least once a week) to avoid data loss.

Note



- After the first synchronisation with the app, your smartwatch automatically assumes the time, date and language from your smartphone.
- The time and date cannot be set manually.
- The display language of your smartwatch depends on your selection in the app. As long as the set-up work has not been finalized, the display language remains English. Select the required display language in the app (see Chapter **9.3.8.11 Smartwatch language setting**).
- The app will alert you when a firmware update is available for your smartwatch. Perform the update in the app to ensure the smartwatch continues to work properly.



7. Operating the smartwatch

The following sections contain information on the operation and menu structure of your smartwatch. The smartwatch is provided with a display equipped with a touchscreen.

- To navigate through the menus and execute function, tap on the respective symbols and menus or swipe as necessary over the screen.
- Press the top control button **[1]** or bottom control button **[2]** to activate the display on your smartwatch. You can then swipe the display to switch between the different views and menu options in the order indicated below.
- You can access the submenus by tapping on the respective symbol.
- Press the top control button **[1]** to open the main menu or exit from a menu and skip back to the home screen.
- Press the bottom control button **[2]** to open the Workout menu. You can use the menu to start a sport mode or an activity.
- By pressing on the top control button **[1]** for a longer period, you can open the Alexa voice control. A condition for use is that the Alexa voice control has been set-up (see Chapter **9.3.7 Alexa voice control**).
- Press the bottom control button **[2]** for a longer period to restart the smartwatch or switch it off.

Note



The following graphic is an overview of the menu structure of your smartwatch with all menu items.

Quick-access settings		7.3
Do not Disturb mode	7.3.1	Alarm clock
Display brightness	7.3.2	Energy-save mode
Wake screen	7.3.3	Telephone search
Torch	7.3.4	Settings
Drainage	7.3.5	

Shortcuts	7.4
Workout data	7.6.1
Steps	7.6.1
Push for measurement	7.6.6
Sleep	7.6.11
Workout (sport modes)	7.5
Weather	7.6.21
Music	7.6.22
Alexa	7.6.16

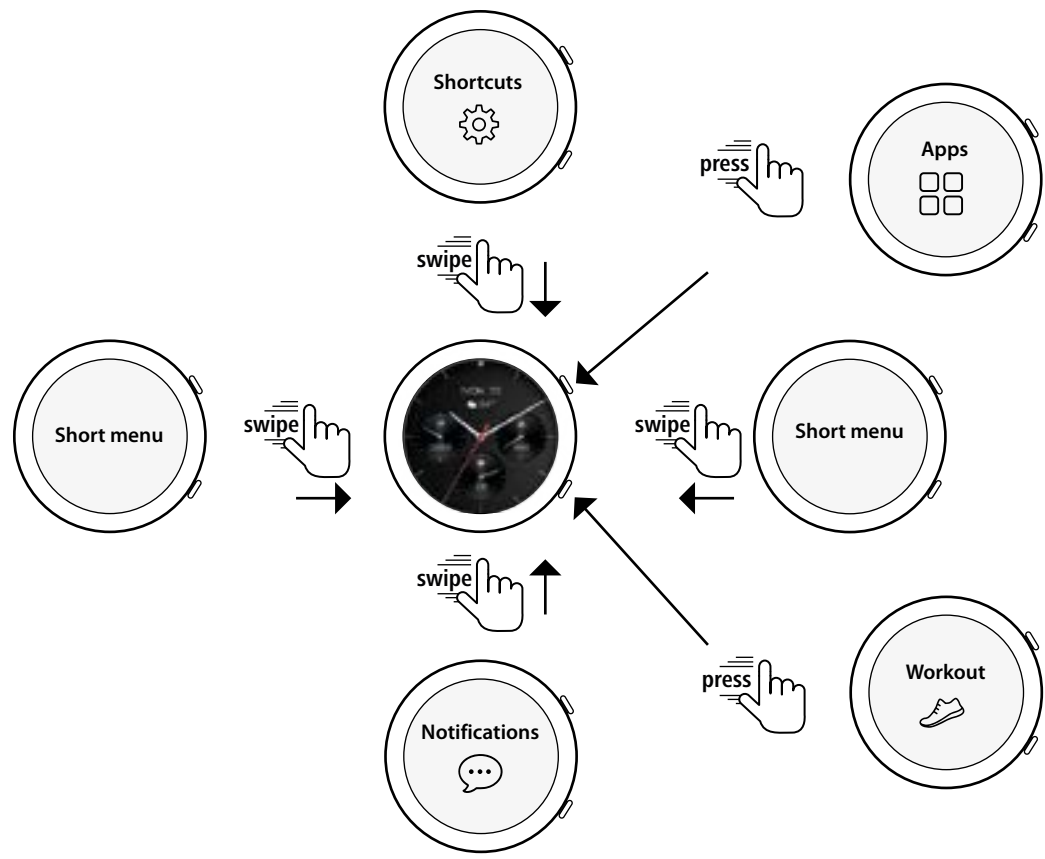

Notifications 7.2

Applications		7.6
Activity	7.6.1	Alexa
Workout status	7.6.2	Barometer
Running courses	7.6.3	Compass
Workout (sport modes)	7.5	Pomodoro technique
Workout record	7.6.5	Event reminder
Push for measurement	7.6.6	Weather
Heart rate	7.6.7	Music
SpO2	7.6.8	Camera
Stress	7.6.9	Alarm clock
Body energy	7.6.10	Timer
Sleep	7.6.11	Stopwatch
Breath training	7.6.12	World clock
Cycle report	7.6.13	Telephone search
Ambient sound	7.6.14	Torch
Phone	7.6.15	Settings
		8

Workout (sport modes) 7.5



7.1 Home screen

- After activating the home screen, pressing on the display for a longer period opens an overview of the different home screens (watch faces). You can select one of the various home screens. Confirm your selection by tapping on the respective home screen. If required, you can install further home screens (see Chapter **9.3.1 Home screen**).



7.2 Notifications

- If you swipe upwards on the home screen, you can view the notifications you have received on your smartphone. The condition for this is that you have activated this function in the app. You can also use the app to define the apps from which you want to receive notifications on the smartwatch (see Chapter **9.3.2 Notifications**).
- Depending on the app, you will either only receive a notification with a display of the app in question and the sender or you will also see a preview of the respective message.
- By tapping on a notification, you can open further information, if necessary.
- If you want to delete all notifications together, swipe all the way down and then tap the waste bin and confirm the subsequent prompt.



7.3 Quick-access settings

- If you swipe down on the home screen, the quick-access settings appear which are described below.



7.3.1 Do Not Disturb mode

- Tap on the [🌑] symbol to activate/deactivate Do Not Disturb mode.
When Do Not Disturb mode is activated, ringing tones and vibrations are deactivated and the display is not activated by incoming push notifications.

7.3.2 Display brightness

- Tap on the [☀️] symbol to adjust the brightness of the display to one of 5 settings.

7.3.3 Wake screen

- Tap on the [👉] symbol to enable activating the screen by moving your arm. When this function is enabled, you can switch on the display by turning your wrist.

7.3.4 Torch

- Tap on the [🔦] symbol to use the smartwatch display as a torch.

7.3.5 Drainage

- Tap on the [💧] symbol to drain off any moisture in the smartwatch, which has entered through the loudspeaker and microphone openings, by means of vibration.

7.3.6 Alarm clock

- Tap on the [🕒] symbol to set an alarm clock.

7.3.7 Energy-save mode

- Tap on the [🔒] symbol to activate energy-save mode.

7.3.8 Telephone search

- Tap on the [📞] symbol to activate the ringing tone of the smartphone. This enables you to locate the smartphone if you have misplaced it.

7.3.9 Settings

- Tap on the [⚙️] symbol to gain access to the following settings (see Chapter

8. Smartwatch settings):

- Watch faces
- AOD settings
- Sound and vibration
- Display & brightness
- App view
- DND (do not disturb)
- Connect more
- System
- About



7.4 Shortcuts

- Swipe to the left or right on the home screen to see your set shortcuts. The daily workout overviews are set by default. Your workout data (number of steps walked and calories burned) is displayed as well as the heart rate and stress measurements. You can set the weather notification and music control, amongst others, as additional shortcuts (see Chapter 9.3.8.10 Shortcuts).



7.5 Workout (sport modes)



- Tap on **[WORKOUT]**  or press the bottom control button **[2]** to open the range of workout activities stored.
- After selecting a workout, you can tap on the bottom screen edge to define the settings for the activity.
- Tap on **[START]** to start the activity.
- Depending on the activity selected, sport-related measured values (e.g. heart rate, calories burned) are displayed.
- You can access the individual data during the workout by swiping from bottom to top on the screen.
- You can have a pause in the workout or stop it by swiping from left to right on the screen. Alternatively, have a pause in the workout by tapping briefly on the top control button **[1]** or stop the workout by pressing the top control button **[1]** for longer.
- While completing most workouts, you can control the music on the smartphone swiping from right to left on the screen during the workout.
- After finishing the workout, more data recorded is displayed. Scroll through the data by swiping from the bottom to the top on the screen.



Note

- Some activities which are completed outdoors use the integrated GPS. When starting the activity, the GPS signal is searched for. As soon as a GPS signal is available, you can start the activity. Alternatively, you can start the activity without a GPS signal. Depending on the activity selected, some data cannot be recorded without a GPS signal.
- Please note that it may take a few minutes for the GPS signal to be detected by the smartwatch. This particularly applies when the integrated GPS is used for the first time, has not been used for a longer period or where it is at a location far away from that where it was last GPS location detected. Shorten the time by linking the smartwatch to the app on your smartphone for the transfer of A-GPS data. If necessary, you will receive a prompt regarding this on the display of your watch.

7.5.1 Defining workouts (sport modes) for display

- There are 110 workouts available for selection and you can store up to 20 on your smartwatch.
- Tap on **[WORKOUT]**  and scroll to the end of the list by swiping from the bottom to the top on the screen. Tap on **[SETTINGS]**  and on **[WORKOUT MANAGEMENT]**. Select the workouts required from the categories. The workouts indicated on the smartwatch are assigned a  symbol.
- Alternatively, define the workouts displayed via the app (see Chapter 9.3.8.2 Type of activity).



7.6 Applications

- Press the top control button [1] to access the main menu of your smartwatch.
- In the main menu you have the option of calling up various applications and sub-menus by tapping on the respective symbol.
- Swipe up and down to switch between the different pages in the main menu.

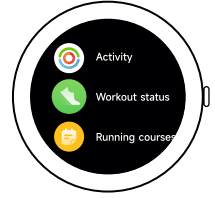

7.6.1 Activity



- After tapping on [ACTIVITY , the following recorded daily data appears:
 - the calories burned
 - the duration of activities with moderate to high intensity
 - the pause time
 - the steps walked
- Swipe from bottom to top to scroll through the individual graphics.

Note

You can define individual goals (e.g. for activity calories or steps) in the app (see Chapter 9.4.6 **Settings**). These goals are then also displayed.



7.6.2 Workout status

- After tapping on [WORKOUT STATUS , VO2max provides the recommended recovery time and aerobic effect of other important parameters for your individual workout management.
- Swipe from bottom to top to scroll through the individual graphics.
- Tap on the  symbol to open more information on the parameters displayed.

7.6.3 Running courses

- After tapping on [RUNNING COURSES , the following running course modes are displayed:
 - Easy run - 6 min.
 - Easy run - 10 min.
 - Easy run - 15 min.
 - Fitness run - easy
 - Fitness run - moderate
 - Fitness run - difficult

When running, you switch between walking and jogging and increase the demands made of your body with each further mode. Swipe from bottom to top to scroll through the individual modes.

7.6.4 Workout (sport modes)

- Tap on [WORKOUT ] to open the activities assigned (see Chapter 7.5 **Workout (sport modes)**).



7.6.5 Workout record

- Tap on **[WORKOUT RECORD **] to open an overview of the activities recorded.
- Tap on an activity to display detailed information.

7.6.6 Push for measurement

- Tap on **[PUSH FOR MEASUREMENT **] to start the combined measurement of heart rate, blood oxygen (SpO2) and stress level.

7.6.7 Heart rate

- Tap on **[HEART RATE **] to start the manual measurement of your heart rate.
- The display shows the average heart rate, the max. and min. values and further data on the heart rate range and heart rate variability (HRV).

7.6.8 Blood oxygen (SpO2)

- Tap on **[SPO2 **] to start measurement of the blood oxygen (oxygen saturation) manually.
- The average blood oxygen value and the max. and min. values are displayed.

7.6.9 Stress

- Tap on **[STRESS **] to open an overview of the stress levels measured during the current day. The stress level is measured according to a scale (0 = no stress - 99 = extreme stress).

7.6.10 Body energy



- Tap on **[BODY ENERGY **] to display your current body energy level. The body energy value is derived from a combination of the heart rate variability, stress, sleep and activities completed and estimates your energy reserves for the current day.
- In order to use the **Body Energy** function, the corresponding function must be activated in the app (see Chapter 9.3.5.1 **Body energy**).

7.6.11 Sleep

- Tap on **[SLEEP **] to access the sleep measurement values. The following data is recorded:
 - Time of falling asleep
 - Time of getting up
 - Duration of deep sleep phases
 - Duration of light sleep phases
 - Duration of wake phases
 - Duration of REM phase
 - Sleep score (0 = poor - 99 = good)
- The smartwatch automatically detects when you are sleeping and then starts the sleep measurements.



7.6.12 Breath training

- Tap on **[BREATH TRAINING **] to access the breathing training function. You can use it to complete a relaxation program with guided breathing methods.
- Select the rhythm (slow, moderate, fast) and duration (1 - 3 min.) for the breathing training.
- Tap on the **[**] symbol to start the breath training programme. Then following the instructions on the display.
- If you want to end the breathing training programme prematurely, press the top control button **[1]** and confirm the subsequent prompt.
- After concluding the breathing training programme, your heart rate before and after the programme are displayed.

7.6.13 Cycle report

- Tap on **[CYCLE REPORT **] to display an overview of your menstrual period.
- In order to use the **Cycle report** application, the corresponding function must be activated in the app (see Chapter **9.3.5.8 Tracking the menstrual period**).

7.6.14 Ambient sound

- Tap on **[AMBIENT SOUND **] to record the current ambient noise (in dB). Keep your arm still until the recording process has finished. The following data is displayed:
 - Current ambient sound
 - Min. value
 - Max. value
- Tap on **[HELP]** to open more information.

7.6.15 Phone

- Tap on **[PHONE **] to gain access to the telephone functions with the following options:
 - Favourite contacts
 - Call list
 - Dialling keypad
- You can make calls directly via the smartwatch and then carry out the conversations using the smartphone connected.
- In order to use the **Telephone** application, your smartwatch must be connected to your smartphone.



7.6.16 Alexa

- Tap on **[ALEXA **] in order to use the Alexa voice control function.
- You can then use voice commands to execute functions. Some examples of using voice commands are provided below:
 - Alexa, what is the weather like in Berlin?
 - Alexa, set the alarm clock to 8 a.m.
 - Alexa, make a note: "Buy eggs and bread".
- In order to use the **Alexa** application, the corresponding function must be set-up and activated in the app (see Chapter **9.3.7 Alexa voice control**). To set-up the function, you require an Amazon account.
- Further information on the voice commands is available in the app, at:
[DEVICE] > [HOW TO USE] > [AMAZON ALEXA].





7.6.17 Barometer

- Tap on **[BAROMETER **] in order to use the smartwatch as a barometer.
- The barometer displays the current air pressure (hPa) and altitude (m).
- The barometer measures the altitude by comparing the air pressure with the atmospheric pressure at sea level.

7.6.18 Compass

- Tap on **[COMPASS **] in order to use the smartwatch as a compass.

7.6.19 Pomodoro technique

- Tapping on **[POMODORO TECHNIQUE **] provides you with the option of selecting from various timers or to set a user-defined timer.
- The Pomodoro technique is a method of time management in which short-term timers are used to divide work into periods of 25 minutes (so called pomodori) with subsequent pause times.
- To start the timer, tap on the **[**] symbol. To enter a pause for the timer, tap on the **[**] symbol. To conclude the measurement, tap on the **[**] symbol.

7.6.20 Event reminder

- Tap on **[EVENT REMINDER **] to display the events which have been saved.
- In order to use the **Event reminder** application, the events must be entered in the app (see Chapter **9.3.6 Event reminder**).



7.6.21 Weather

- Tap on **[WEATHER **] to open the weather forecast for the respective day, including the current temperature as well as the lowest and highest values. Swipe upwards to display further information and the weather forecast for the following days.
- The weather data is transmitted and updated by synchronising your smartwatch with the app. The most recent update appears at the bottom edge of the weather display screen.
- In order to use the **Weather** application, the corresponding function must be set-up and activated in the app (see Chapter **9.3.8.7 Weather notification**).

7.6.22 Music

- Tap on **[MUSIC **] to open the control view for various music and streaming services. They can be controlled on the smartphone via your smartwatch. You can start or stop the music, skip forward or back in the tracks and regulate the volume.
- In order to use the **Music** application, the corresponding function must be set-up and activated in the app (see Chapter **9.3.8.4 Music control**).

7.6.23 Camera

- By tapping on **[CAMERA **], you can use the smartwatch to control the camera on the smartphone connected.
- In order to use the **Camera** application, the smartwatch and smartphone must be connected via Bluetooth and the camera function must be activated on the smartphone.

7.6.24 Alarm clock

- After tapping on **[ALARM CLOCK **], you can set an alarm time. You can activate or deactivate the alarm clock or alarm reminder by tapping on the respective times.
- You can also set and manage the alarm times in the app, and also synchronise them with the smartwatch (see Chapter **9.3.4 Alarm clock**).

7.6.25 Timer

- Tapping on **[TIMER **] provides you with the option of selecting from various timers or to set a user-defined timer.
- To start the timer, tap on the **[▶]** symbol. To enter a pause for the timer, tap on the **[||]** symbol. To conclude the measurement, tap on the **[✕]** symbol.

7.6.26 Stopwatch

- Tapping on **[STOPWATCH **] enables you to use the smartwatch as a stopwatch.
- To start the stopwatch, tap on the **[▶]** symbol. To interrupt the stopwatch, tap on the **[||]** symbol. To conclude the measurement, tap on the **[✕]** symbol.

7.6.27 World clock

- Tap on **[WORLD CLOCK **] to display the following world clocks:
Berlin, London, New York, Tokyo
- If so required, you can set-up more world clocks in the app (see Chapter **9.3.8.8 World clock**).

7.6.28 Telephone search

- Tap on **[TELEPHONE SEARCH **] to start a search for your smartphone should you have misplaced it. Your smartphone starts vibrating or issues a loud acoustic signal.
- In order to use the **Telephone search** application, your smartwatch and smartphone must be connected via Bluetooth.



8. Smartwatch settings

The following sections contain information on the smartwatch settings.

- Press the top control button [1] and tap on [SETTINGS 

8.1 Watch faces

- After tapping on [WATCH FACES 

8.2 AOD settings

- After tapping on [AOD SETTINGS - Set a time period for the AOD function (standard setting 08:00 - 22:00).
- Define a watch face for the AOD function.

8.3 Sound and vibration

- After tapping on [SOUND AND VIBRATION - Tap on [SILENT MODE] to mute calls and notifications.
- Tap on [MEDIA VOLUME] to regulate the volume of media being played back.
- Tap on [VIBRATION] to set the strength of vibration to one of 3 levels (strong, low, none).
- Tap on [INCOMING CALL RINGTONE] to define a ringing tone for incoming calls.

8.4 Display and brightness

- After tapping on [DISPLAY AND BRIGHTNESS - Tap on [BRIGHTNESS] to set the brightness of the display to one of 5 levels (20%, 40%, 60%, 80%, 100%). Please note that the battery power consumption of the smartwatch increases with higher brightness.
- Tap on [SCREEN-ON TIME] to set the switch-on time of the display (5 - 20 sec.). The screen-on time defines how long the display of the smartwatch remains active following an operation. Please note that the battery power consumption of the smartwatch increases as the screen-on time increases.
- Tap on [COVER TO SLEEP] to switch off the display automatically when it is covered (e.g. by the hand).

8.5 App view

- Tap on [APP VIEW 



8.6 DND (Do Not Disturb)

- After tapping on **[DND **] you can activate the "Do Not Disturb" function. When the function is activated, ringing tones and vibrations are deactivated and the smartwatch display is not activated by incoming push notifications.
- Choose between the following modes:
 - **[ALL-DAY DND]**, the function is switched on.
 - **[SCHEDULED DND]**, you can define a start and end time.
 - **[OFF]**, the function is switched off.

8.7 Connect more





- After tapping on **[CONNECT MORE **] you can connect the smartwatch with another smartphone. Follow the instructions in the smartwatch display.

Note



Please note that when you use this function, the current connection to your smartphone is disconnected.

8.8 System

- After tapping on **[SYSTEM **] you can activate other functions.
- After tapping on **[RESTART **] and confirming the subsequent prompt, you can restart the smartwatch.
- After tapping on **[TURN OFF **] and confirming the subsequent prompt, you can switch off the smartwatch.
- After tapping on **[RESET **] and confirming the subsequent prompt, you can reset your smartwatch to its factory default settings. This deletes all recorded user data.

8.9 About

- After tapping on **[ABOUT **] the model name, MAC address, current firmware version of the smartwatch and information on legal regulations appear. The MAC address provides the smartwatch with a unique identification when establishing a Bluetooth connection to your smartphone.



9. Using the "Hama FIT move" app

The following sections explain the individual menu items (cards) and the various setting options within the app in more detail.

Note



- Please note that the use of some functions is dependent on the smartphone supporting them (see the operating instructions provided with your smartphone).
- Not all menu items (cards) are displayed on the home screen by default. Unhide the required menu items (cards) as necessary.

9.1 "Hama FIT move" overview

The home screen represents the starting point for using the "Hama FIT move" app.

The following overview explains the most important control elements and views:

1. Display of workout data
2. Display of steps
3. Display of other cards
4. Menu bar



- Tap on **[EDIT CARD]** at the bottom of the home screen to select the cards to be displayed on the home screen. You can choose from a total of 8 different cards. You can hide cards and alter the sequence of the cards.
- The cards that are at the top of the list and are marked by the **[REDACTED]** symbol are currently displayed on the home screen. The cards that are at the bottom of the list and marked by the **[GREEN]** symbol are not displayed.
- Tapping on the **[REDACTED]** symbol or the **[GREEN]** symbol removes a card or adds a card respectively.
- You can also change the sequence of the cards saved by pressing and holding the **[LIST]** symbol and moving the corresponding cards to the respective positions.



9.1.1 Workout data

- Open the home screen and tap on the first graphic at the top to view your workout data.
- An overview of the following workout data is provided here:
 - the calories burned
 - the duration of the activities with moderate to high intensity
 - the pause time ("walking" = hours in which you stood for at least 1 minute and moved)
- Normally, the daily view of the workout data is displayed. Select the period displayed in the top menu bar One Week Month Year.
- To obtain more information, swipe upwards on the smartphone screen. Further down, you can see detailed information on the Activity, Exercise and Walking categories.





9.1.2 Step measurement

- Tap on the second graphic at the top of the home screen to view the steps recorded.
- An overview of the steps made in the current day is provided here.
- Normally, the daily view of the step measurement is displayed.
Select the period displayed in the top menu bar **Day** **Week** **Month** **Year** . Swiping to the left and right on the diagram for a longer time enables you to scroll forward and back between the individual days (or weeks/months/years). In addition, your set steps goal is also displayed graphically in the diagram.
- Tap on the  symbol to define further settings (see Chapter **9.4.3 My data**).

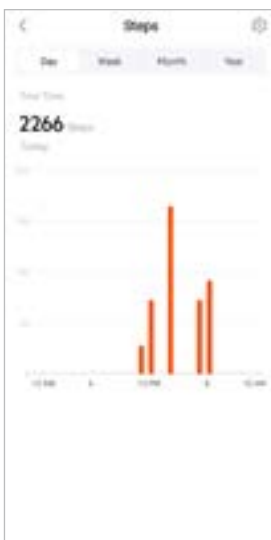



9.1.3 Activity records

- Tap on the **[ACTIVITY RECORDS]** card to obtain an overview of your training activities.
- This provides an overview of the activities arranged according to days. The overview includes the total time, average weekly duration, accumulated exercise and calories burned.
- Tap on the [📅] symbol to expand the selected month and display the respective training activities. Tap on the [📅] symbol to collapse the day.
- To display the activities related to a specific type of sport, tap on the [☰] symbol.
- To open the detailed view of a recorded activity, tap the activity. You will then see detailed data recorded on the activity. For example, you can see the course of the route that was recorded via GPS as well as the duration of the activity, the steps taken and the distance covered, the calories burned or your pace. You also receive a detailed evaluation of your heart rate.





9.1.4 Sleep analysis

- Tap on the **[SLEEP]** card to obtain an overview of your sleep analyses.
- Here you can see an overview of the total sleep time as well as the distribution of your sleep time into deep sleep, light sleep, waking phases and REM phases. In the centre of the screen you can also see the start and end times of the sleep.
- Normally, the daily view of the sleep analysis is displayed.

Use the top menu bar **Day** **Week** **Month** **Year** to select the period displayed. Swiping to the left and right on the diagram for a longer time enables you to scroll forward and back between the individual days (or weeks/months/years). Here you can see an overview of your sleep patterns for a week, a month or a year. At the bottom of the screen you will see the following data related to a week, a month or a year:

- Average duration of sleep per day
- Average deep sleep phase on one day
- Average light sleep phase on one day
- Average start of sleep phase
- Average end of sleep phase
- Average REM phase
- Average waking phase





9.1.5 Heart rate measurement

- Tap on the **[HEART]** card to obtain an overview of your heart rate measurement.
- You can view all the heart rate measurement values recorded here (automatic and manual) as well as an overview of your average heart rate, heart rate range and resting heart rate for the respective day. By swiping lightly to the left and right on the diagram, you can call up the individual values with the respective time.
- Normally, the daily view of the heart rate measurement is displayed. Use the top menu bar **Day** **Week** **Month** **Year** to select the period displayed. Swiping to the left and right on the diagram for a longer time enables you to scroll forward and back between the individual days (or weeks/months/years).
- Tap on the  symbol to define further settings.





9.1.6 Stress measurement

- Tap on the **[STRESS]** card to obtain an overview of your stress measurement.
- You can view all the stress measurement values recorded here (automatic and manual) as well as an overview of your average stress level, stress range and a graphic of your stress zone for the respective day. By swiping lightly to the left and right on the diagram, you can call up the individual values with the respective time.
- Normally, the daily view of the stress measurement is displayed.
Use the top menu bar **Day** **Week** **Month** **Year** to select the period displayed. Swiping to the left and right on the diagram for a longer time enables you to scroll forward and back between the individual days (or weeks/months/years).
- Tap on the  symbol to define further settings.

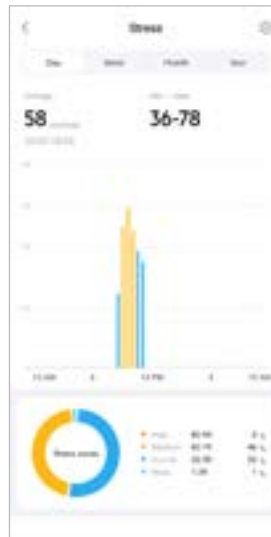



9.1.7 Blood oxygen (SpO2)

- Tap on the **[SPO2]** card to obtain an overview of your blood oxygen measurements. The measurement can be completed manually via your smartwatch (see Chapter **7.6.8 Blood oxygen (SpO2)**).
- Alternatively, set the automatic blood oxygen measurements:
Tap on the **[📷]** symbol to complete the necessary settings.
- An overview of all the values recorded for the blood oxygen measurements as well as the lowest and highest values are displayed for the respective day. By swiping lightly to the left and right on the diagram, you can call up the individual values with the respective time.
- Normally, the daily view of the blood oxygen measurement is displayed.
Use the top menu bar **Day** **Week** **Months** **Year** to select the period displayed. Swiping to the left and right on the diagram for a longer time enables you to scroll forward and back between the individual days (or weeks/months/years).





9.1.8 Ambient sound level

- Tap on the **[AMBIENT SOUND LEVEL]** card to obtain an overview of ambient sound level measurement. The measurement can be completed manually via your smartwatch (see Chapter **7.6.14 Ambient sound**).
- An overview of all the values recorded for the ambient sound level as well as the lowest and highest values are displayed for the respective day. Recordings for other days can be displayed by swiping lightly to the left and right on the diagram.
- Normally, the daily view of the ambient sound level is displayed.
Use the top menu bar **Day** **Week** **Month** **Year** to select the period displayed. Swiping to the left and right on the diagram for a longer time enables you to scroll forward and back between the individual days (or weeks/months/years). The measured values are also displayed as a curve graph.





9.1.9 Weight

- Tap on the **[WEIGHT]** card to obtain an overview of your weight record.
- Your weight history, BMI and set target value are displayed here.
- Tap on **[RECORD WEIGHT]** to enter your current weight.
- Tap on **[EDIT GOAL]** to edit your target weight.
- Normally, the daily view of the weight record is displayed.

Use the top menu bar **Day** **Week** **Month** **Year** to select the period displayed. Swiping to the left and right on the diagram for a longer time enables you to scroll forward and back between the individual days (or weeks/months/years). The measured values are also displayed as a curve graph.











9.1.10 VO2max

- Tap on the **[VO2MAX]** card to obtain an overview of your relative VO2max (oxygen per minute per kilogram of body weight).
- A condition for establishing the VO2max is that workouts are completed in **Outdoor running, Trail running** or **Orienteering** sport modes. In this case, the heart rate measurement for the workout must contain a minimum period of 90 seconds at over 75% of your theoretical maximum heart rate. This is established using the personal data you have entered.

9.1.11 Heart rate variability (HRV)

- Tap on the **[HEART RATE VARIABILITY (HRV)]** card to obtain an overview of your heart rate variability (HRV).
- A condition for establishing the heart rate variability (HRV) is that the continuous heart rate measurement function is activated in the app:
Tap on the  symbol to define the relevant settings.

9.1.12 Body energy

- Tap on the **[BODY ENERGY]** card to obtain an overview of your body energy. The body energy value is derived from a combination of the heart rate variability, stress, sleep and activities completed and estimates your energy reserves for the current day.
- Normally, the daily view of the body energy is displayed.
Use the top menu bar     to select the period displayed. Swiping to the left and right on the diagram for a longer time enables you to scroll forward and back between the individual days (or weeks/months/years).
- A condition for displaying the body energy on the smartwatch is that the **Automatic detection of the body energy** function has been activated in the app:
Tap on the  symbol to define the corresponding settings.

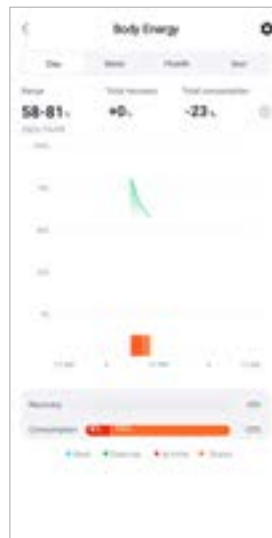



9.1.13 Menstrual period

- Tap on the **[PERIOD TRACKING]** card to obtain an overview of your menstrual cycle.
- Tap on **[+ SRECORD PERIOD DAYS]** to enter your current menstruation.





9.2 Training mode

- Use the bottom menu bar to tap on **[EXERCISE]** to start an activity via the app. Parallel to this, the activity is also started on your smartwatch. The activity can then be controlled either via the app or directly on the smartwatch.
- Swipe to the left and right to move forward and back between the individual activities.
- The following activities are activated in the app by default:
 - Outdoor running
 - Indoor running
 - Outdoor walking
 - Indoor walking
 - Hiking
 - Outdoor cycling
- Tap on the [☰] symbol at the top right and then on **[EDIT SPORTS MODE]** to select the activities which are displayed. You can choose from a total of 6 different activities. You can hide activities and alter the sequence of the activities.
- The activities that are at the top of the list and marked by the [🔴] symbol are displayed. The activities that are at the bottom of the list and marked by the [🟢] symbol are not displayed.
- You can tap on the [🔴] symbol or the [🟢] symbol to remove or add an activity, respectively.
- You can also change the sequence of the activities by pressing and holding the [☰] symbol and moving the corresponding activities to the respective positions.
- Tap on the [⚙️] symbol to define the following settings:
 - Set a training goal (distance, calories, steps, duration).
 - Activate an alarm to sound on reaching the goal (1, 3, 5, 10 km).
 - Set a heart rate zone and activate an alarm.

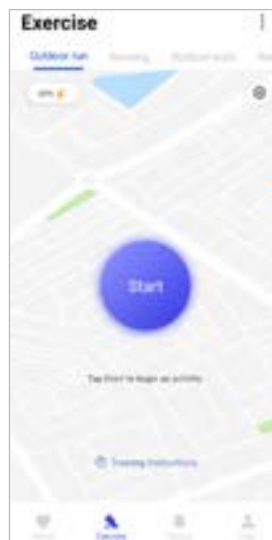







9.2.1 Start an activity (with GPS)

- The following activities are recorded with GPS support:
 - Outdoor running
 - Outdoor walking
 - Hiking
 - Outdoor cycling
- Tap on **[START]** to start the activity. The activity starts on the smartphone and the smartwatch.
- While the activity is in progress, you can see the cumulative number of kilometres covered so far for the selected activity, the current pace, the time elapsed and your current heart rate.

Operation using the smartphone

- To display a map containing your current location and distance covered so far while an activity is in progress, tap on the  symbol.
- To lock the overview of the recording while an activity is in progress, tap on the  symbol.
- To interrupt the activity, tap on the  symbol.
- To end the activity, tap on the  symbol and keep your finger pressed until a circle closes around the symbol and the activity is ended.



Operation using the smartwatch

- To interrupt the activity, press the top control button **[1]**.
- To end the activity, press and hold the top control button **[1]** and then tap on the  symbol.



- After ending an activity, an overview of the activity is displayed. The overview contains the total number of kilometres covered so far, the calories burned, the average heart rate and duration of the activity. It also includes more detailed information on the pace and steps. Use your finger to swipe from the bottom to the top to display details of the heart rate measurement and pace.
- You can print out the results of the activity or forward them as a screenshot.

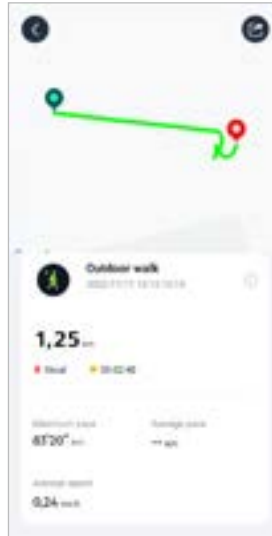





9.2.2 Start an activity (without GPS)

- The following activities are recorded without GPS support:
 - Indoor running
 - Indoor walking
- Tap on **[START]** to start the activity. The activity starts on the smartphone and the smartwatch.
- While the activity is in progress, you can see the cumulative number of kilometres covered so far for the selected activity, the current pace, the time elapsed and your current heart rate.

Operation using the smartphone

- To lock the overview of the recording while an activity is in progress, tap on the  symbol.
- To interrupt the activity, tap on the  symbol.
- To end the activity, tap on the  symbol and keep your finger pressed until a circle closes around the symbol and the activity is ended.



Operation using the smartwatch

- To interrupt the activity, press the top control button **[1]**.
- To end the activity, press and hold the top control button **[1]** and then tap on the  symbol.



- After ending an activity, an overview of the activity is displayed. The overview contains the total number of kilometres covered so far, the calories burned, the average heart rate and duration of the activity. It also includes more detailed information on the pace and steps. Use your finger to swipe from the bottom to the top to display details of the heart rate measurement and pace.
- You can print out the results of the activity or forward them as a screenshot.





9.3 Device settings

- Tap on **[DEVICE]** in the bottom menu bar to activate and set various functions of the smartwatch and to adapt the smartwatch to your individual needs.
- In this menu, you will also see an overview of various items of data from your connected smartwatch at the top of the screen.
- Tap on **[+]** to pair more devices to the smartphone.
- Tap on your device to obtain information on your smartwatch or execute advanced functions.
- Tap on **[DEVICE UPGRADE]** to check whether the latest firmware version has been installed on your smartwatch or there is a new firmware version available to be downloaded and installed on your smartwatch.
- Tap on **[RESTART THE DEVICE]** and confirm the subsequent prompt to restart your smartwatch. Before restarting, your data will be synchronised with the app.
- Tap on **[DEVICE RESTORE THE FACTORY DEFAULT SETTING]** and confirm the subsequent prompt to reset the smartwatch to its default factory settings. This deletes all recorded user data.
- Tap on **[DELETE DEVICE]** to revoke the pairing between the smartwatch and smartphone. All personal data will be deleted from your smartwatch.

Note



To display the time at which the last synchronisation between your smartwatch and app occurred, tap on your device displayed at the top and on the **[ABOUT]** button.

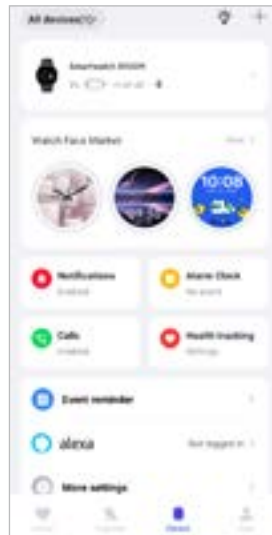



9.3.1 Home screen

- Tap on **[WATCH FACE MARKET]** to install additional watch faces for the home screen of your smartwatch. You can select between various watch faces. Tap on the respective watch face which you want to set-up on the smartwatch and then confirm your selection with **[INSTALL]**. If you have reached the maximum number of watch faces that may be installed on the device, you will be requested to delete existing watch faces.



9.3.2 Notifications

- Tap on **[NOTIFICATIONS]** to activate the notification function for various apps and services. When this function is activated, you receive notification on the smartwatch when a message is received on your smartphone. Depending on the app, you will either only receive a notification with a display of the respective app and the sender or you will also see a preview of the message.
- You must select whether notifications should be permitted, muted or deactivated for each app and health function.

9.3.3 Calls

- Tap on **[CALLS]** to activate the notification for incoming calls. When this function is activated, you receive a notification on the smartwatch in the event of an incoming call. You can see who is calling, and you can reject the call if necessary.
- Tap on **[**] on the right-hand edge of the screen to activate the function. You can then set-up the **[FREQUENT CONTACTS]** function.

9.3.4 Alarm clock

- Tap **[ALARM CLOCK]** to set alarm times or reminders.
- To add a new reminder, tap on **[+]** in the centre of the screen.
- Tap on **[**] on the right-hand edge of the screen to activate the alarm clock just set-up.
- You can edit the reminder created by tapping on it. You can use the submenu to set the reminder type, the respective weekdays and the time for the reminder and more details.



9.3.5 Health monitoring

- Tap on **[HEALTH MONITORING]** to set functions which monitor your health and remind you to exercise and/or drink water.

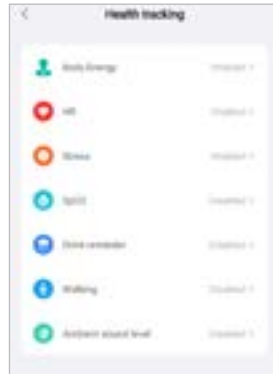

9.3.5.1 Body energy

- Tap on **[BODY ENERGY]** to be able to activate/deactivate this function in the submenu by tapping on

9.3.5.2 Heart rate measurement

- Tap on **[HR]** to define further settings.
- Select whether notifications should be permitted, muted or switched off.
- Tap on to activate continuous heart rate measurement. The measuring frequency is based on an intelligent monitoring method, 24 hours a day.

9.3.5.3 Stress measurement

- Tap on **[STRESS]** to define further settings.
- Select whether notifications should be permitted, muted or switched off.
- Tap on to activate automatic stress measurement. The measuring frequency is based on an intelligent monitoring method, 24 hours a day.

9.3.5.4 Blood oxygen measurement

- Tap on **[SPO2]** to define further settings.
- Select whether notifications should be permitted, muted or switched off.
- Tap on to activate automatic blood oxygen measurement. The measuring frequency is based on an intelligent monitoring method, 24 hours a day.

9.3.5.5 Drink reminder

- Tap on **[DRINK REMINDER]** to activate/deactivate this function in the submenu by tapping on . You can then define further settings related to the drink reminder function. Your smartwatch then automatically reminds you to drink something at a set interval by means of vibration and notification.

9.3.5.6 Exercise reminder

- Tap on **[WALKING]** to activate/deactivate this function in the submenu by tapping on . You can then define further settings related to the reminder function. Your smartwatch then automatically reminds you to exercise a little at a set interval by means of vibration and notification. Further information is provided in the text below in the app.



9.3.5.7 Ambient sound level

- Tap on **[AMBIENT SOUND LEVEL]** to activate/deactivate this function in the submenu by tapping on . Further information is provided in the text below in the app.

9.3.5.8 Tracking the menstrual period

- A condition for using this function is that it is activated in the app: **[OTHER SETTINGS] > [MENSTRUAL PERIOD]**
- By activating this function, you can set different dates related to your menstrual cycle and receive reminders about your next period or your fertile phase.
- Use the submenus to define the length of time of the menstrual period, the length of the menstrual cycle and the date of the last day of menstruation.
- Tap on the  symbol to define further settings.



9.3.6 Event reminder

- Tap on **[EVENT REMINDER]** and tap on the **[ADD]** button to add individual events to be reminded of.
- Tap in the input field to enter text. Then define the date, time and number of repeats of the reminder.

The screenshot shows the 'Event reminder' app interface. At the top, there is a title bar with a back arrow on the left and a 'Cancel' button on the right. Below the title bar is a large text input field with the placeholder text 'Please enter the reminder details'. Underneath this field is a 'Done' button. Below the 'Done' button are three rows of settings, each with an icon on the left and a value on the right: 'Date' with a calendar icon and the value '2023/10/01', 'Time' with a clock icon and the value '12:00', and 'Repeat' with a circular arrow icon and the value 'once'.



9.3.7 Alexa voice control

- Tap on **[ALEXA]** in order to set-up the Alexa voice control. Swipe from right to left to open more information.
- Tap on **[LOGIN WITH AMAZON]** and follow the instructions provided in the app.



Note

To use the Alexa voice control function you require an Amazon account.





9.3.8 Other settings

- Tap on **[OTHER SETTINGS]** to define further settings and activate useful functions.

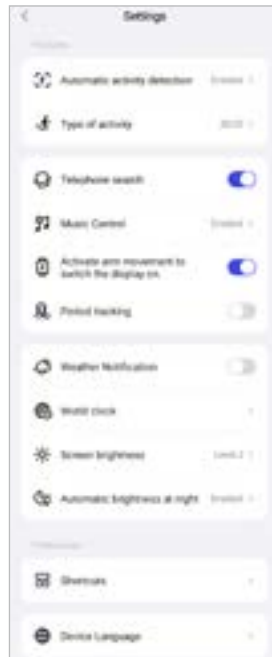

9.3.8.1 Automatic activity detection

- Tap on **[AUTOMATIC ACTIVITY DETECTION]** and activate/deactivate the function in the submenu for specific activities (walking, running, cross trainer, rowing) by tapping on **[ON/OFF]**. When this function is activated, the smartwatch automatically detects when you engage in an activity for a longer period of time and records this activity after confirmation. Further information is provided in the text below in the app.

9.3.8.2 Type of activity



- Tap on **[TYPE OF ACTIVITY]** to select the activities that will be stored on the smartwatch. There are 110 types of activity available for selection whereby 20 can be displayed on your smartwatch. You can hide activities and alter the sequence of the activities. Following the next synchronisation with the smartwatch, the activities will be displayed according to your settings.
- The activities that are at the top of the list and marked by the **[REDACTED]** symbol are currently displayed on the smartwatch. The activities that are at the bottom of the list and marked by the **[GREEN]** symbol are not currently displayed.
- Tap on the **[REDACTED]** symbol or the **[GREEN]** symbol to remove or add an activity, respectively.
- You can also change the sequence of the activities stored by pressing and holding the **[HAMBURGER]** symbol and moving the respective activity to the respective position.



9.3.8.3 Telephone search

- Tap on [] in [TELEPHONE SEARCH] to activate the function. By activating this function, you can find your mislaid smartphone again via the smartwatch (see Chapter 7.6.15 Phone).

9.3.8.4 Music control

- Tap on [MUSIC CONTROL] and activate/deactivate the function in the submenu by tapping on []. When this function is activated, you can control various music or streaming services on the smartphone via the smartwatch. You can start or stop music and skip tracks forward or backward.
- Tap on [] beside [SONG'S TITLE] to display the track title in the display of the smartwatch.

9.3.8.5 Arm movement activation

- Tap on [] beside [ACTIVATE ARM MOVEMENT TO SWITCH THE DISPLAY ON] to activate this function. By activating this function, you can switch the smartwatch display on by turning your wrist.

9.3.8.6 Menstrual period

- Tap on [] beside [PERIOD TRACKING] to activate this function. By activating this function, you can track your menstrual period on your smartwatch (see Chapter 7.6.13 Cycle report).

9.3.8.7 Weather notification

- Tap on [] beside [WEATHER NOTIFICATION] to activate this function. By activating this function, you can view the weather forecasts for the current day and for the following six days on the smartwatch (see Chapter 7.6.21 Weather).

9.3.8.8 World clock

- Tap on [WORLD CLOCK] to view the current world clocks (Berlin, London, New York, Tokyo) or add more world clocks. You can view the world clocks on the smartwatch (see Chapter 7.6.27 World clock).

9.3.8.9 Screen brightness

- Tap on [SCREEN BRIGHTNESS] to set the brightness of the smartwatch display to one of 5 levels (see Chapter 8.4 Display and brightness).



9.3.8.10 Shortcuts

You can open the shortcuts on the smartwatch display by swiping over it to the left or right on the home screen (see Chapter 7.4 Shortcuts).

- Tap on **[SHORTCUTS]** to select the shortcuts to be saved on your smartwatch. You can choose from various different shortcuts. You can hide shortcuts and alter the sequence of the shortcuts. Normally, the daily view of the workout data and measurement of heart rate and stress are set. Following the next synchronisation with the smartwatch, the shortcuts will be displayed according to your settings.
- The shortcuts that are at the top of the list and marked by the **[🔴]** symbol are currently displayed on the smartwatch. The activities that are at the bottom of the list and marked by the **[🟢]** symbol are not currently displayed.
- Tap on the **[🔴]** symbol or the **[🟢]** symbol to remove or add shortcuts, respectively.
- You can also change the sequence of the shortcuts stored by pressing and holding the **[☰]** symbol and moving the respective shortcut to the respective position.

9.3.8.11 Smartwatch language setting

- Tap on **[DEVICE LANGUAGE]** to set the language required on your smartwatch.
- Select **[FOLLOW SYSTEM]** if the language on the smartwatch should be identical to that on the app or smartphone.
- Alternatively, you can choose between eight languages and set them manually by tapping on the respective language.

9.3.9 How to use

- Tap on **[HOW TO USE]** to obtain useful tips, e.g. on the voice commands for Amazon Alexa.



9.4 User settings

- Tap on **[USER]** in the bottom menu bar. You can manage your user account here as well as define your personal data and goals. You can also call up further information on the app, which is shown in the following sections.

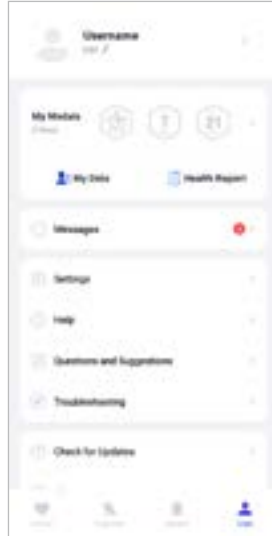



9.4.1 Personal data

- Tap on **[EDIT]**, underneath your user name, in order to edit your name, gender, date of birth as well as your height and weight. You can also set a profile picture, if required. Tap on the entry that you want to edit.
- Tap on **[YES]** to confirm your input.

The screenshot displays the 'Personal data' editing interface. At the top, there is a back arrow and a profile picture placeholder. Below the profile picture is the text 'Username' followed by a pencil icon. The main content area contains several input fields with labels and values:

Field	Value
Gender	Male
Birthday	1988-12-12
Height	178 cm
Weight	85 kg
E-mail	john.doe@example.com
Region	Germany



9.4.2 My medals

- **[MY MEDALS]** displays your personal successes (medals). Tap on an entry to obtain more information.

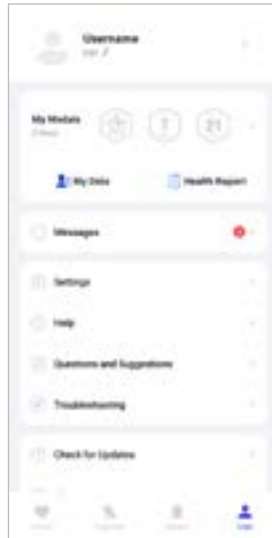

9.4.3 My data

- **[MY DATA]** displays the records related to your measurements. Tap on an entry to obtain more information.





9.4.4 Health report

- **[WEEKLY HEALTH REPORT]** displays the weekly records of your workout data and activities. Tap on a corresponding weekly report to obtain detailed information.



9.4.5 Messages

- **[MESSAGES]** displays an overview of news concerning the app, such as new functions or updates for example.



9.4.6 Settings

- **[SETTINGS]** can be used to define various settings and call up information. You can change the email address stored as well as the password for your user account. You also have the option of logging out from your user account or cancelling the user account completely.
- Tap on **[MY GOALS]** to define personal targets for steps to complete or your weight.
- Tap on **[MANUAL SYNC]** to trigger synchronisation of the data between the smartwatch and app manually.
- Tap on **[PREFERENCES]** to define the units for distance, height, weight and temperature. In addition, you can also define which weekday is the first of the week from which your data will be processed.
- Tap on **[PRIVACY AND SECURITY]** to define which data in the app should be synchronised with the cloud. To delete all data, tap on **[CLEAR PERSONAL DATA ON THE CLOUD]**.
- Tap on **[DATA SHARING AND AUTHORIZATION]** in order to allow the recorded data to be shared with other apps.
- Tap on **[MODIFY EMAIL]** to change the email address of your user account.
- Tap on **[CHANGE PASSWORD]** to change the password of your user account.
- Tap on **[CLEAR CACHE]** to delete the temporary data from the app. No recorded data is lost in this case.
- Tap on **[SIGN OUT]** to log off from the current user account.
- Tap on **[CANCEL ACCOUNT]** and confirm the following prompt to delete your user account. All settings and recorded data are lost in this case.

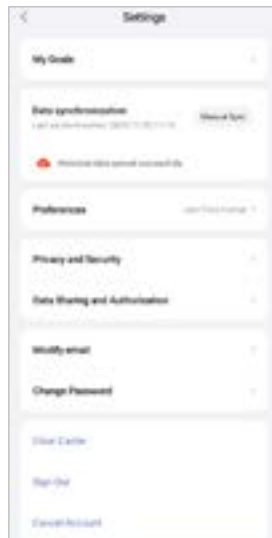



9.4.7 Help

- Tap on **[HELP]** to open an overview of answers to frequently asked questions. Tap on the respective question to obtain more information.
- If your question is not answered, check the information in the Section Keeping the App Running in the Background (see Chapter **9.4.9 Keeping the app running in the background**) or send your query to the Hama advisory service (see Chapter **9.4.8 Questions and suggestions**).

9.4.8 Questions and suggestions

- Tap on **[QUESTIONS AND SUGGESTIONS]** to send a query or feedback to the Hama advisory service.
- Select a subject area and then describe your enquiry in more detail. You can also add images to your request and share the log of the connections between the smartwatch and the app. Always specify your email address with every query.
- Tap on **[SUBMIT]** at the bottom to send a query.

9.4.9 Keeping the app running in the background

- Tap on **[KEEPING THE APP RUNNING IN THE BACKGROUND]** to open an overview of answers to frequently asked questions. Tap on the respective question to obtain more information.
- If your question is not answered, please send query to the Hama product advisory service (see Chapter **9.4.8 Questions and suggestions**).

9.4.10 Check for updates

- Tap on **[CHECK FOR UPDATES]** in order check for a newer version of the "Hama FIT move" app. You are automatically forwarded to Google Play (Android) or the App Store (iOS).

Note

When your smartphone is in its default setting, you should be automatically informed about app updates.



9.4.11 About

- Tap on **[ABOUT]** to open information concerning the app, such as the app version used, privacy policy and usage agreements.
- Tap on **[WITHDRAW CONSENT]** if you want to withdraw your consent to the privacy policy and usage agreements. Please note that use of the app is not possible without this consent.



10. Maintenance and care

Clean the product with a slightly moist, lint-free cloth and do not use any aggressive cleaning agents.

11. Legal disclaimer

Hama GmbH & Co KG assumes no liability and provides no warranty for damage resulting from improper installation/assembly, improper use of the product or from failure to observe the operating instructions and/or safety information.

12. Languages supported

The list below contains the languages in which the smartwatch user interface and "Hama FIT move" app are available:

	English	German	French	Spanish	Swedish	Czech	Polish	Finnish	Hungarian	Dutch	Portuguese	Russian	Romanian	Slovakian	Bulgarian	Greek	Norwegian	Danish	Serbian
Smartwatch 8900	x	x	x	x	x	x	x	x											
Hama FIT move	x	x	x	x	x	x	x	x	x	x	x	x	x	x	x	x	x	x	x

13. Technical data

	00178611	00178612 / 00178613
Bluetooth version	5.3 LE	5.3 LE
Display type	AMOLED full touch	AMOLED full touch
Display size	1.43"	1.32"
Dimensions	269 × 46 × 12 mm	251 × 43 × 10 mm
Weight	43.5 g	39.7 g
Watchstrap length	12.5 cm / 9.8 cm	11.3 cm / 8.8 cm
Watchstrap width / Watch bridge	2.2 cm / 2 cm	2 cm / 1.8 cm
Watchstrap material	Plastic (silicone)	Plastic (silicone)
Housing material	Aluminium / Plastic (ABS+PC)	Aluminium / Plastic (ABS+PC)
Protection class	IP68	IP68
Battery type	Lithium polymer	Lithium polymer
Battery capacity	300 mAh	300 mAh
Charging time	Approx. 2.5 hours	Approx. 2.5 hours
Battery life	Approx. 8 days	Approx. 8 days



14. Information on disposal

Information on environmental protection:



Following the implementation of European Directives 2012/19/EU and 2006/66/EC into the national legal systems, the following applies: Electrical and electronic devices as well as batteries must not be disposed of with household waste. Consumers are obliged by law to return electrical and electronic devices as well as batteries to the designated public collection points or to the point of sale at the end of their service life. Detailed information on this topic is defined in the national laws of the respective country. This presence of the above symbol on the product, operating instructions or package indicates that the product is subject to these regulations. By recycling, reusing the materials or other forms of utilising old devices/batteries, you are making an important contribution to protecting our environment.

15. Declaration of conformity

CE Hama GmbH & Co KG, hereby declares that this device is in compliance with the basic requirements and other relevant provisions of Directive 2014/53/EU. The declaration of conformity in accordance with the relevant directive can be found at:

www.hama.com >  Search > 00178611, 00178612, 00178613 > Downloads

Frequency band/Frequency bands	2402 – 2480 MHz
Maximum transmission power radiated	10 dBm

hama

Hama GmbH & Co KG
86652 Monheim / Germany

Service & Support

 www.hama.com

 +49 9091 502-0

GB

The Bluetooth® word mark and logos are registered trademarks owned by Bluetooth SIG, Inc. and any use of such marks by Hama GmbH & Co KG is under license. Other trademarks and trade names are those of their respective owners.

All listed brands are trademarks of the corresponding companies. Errors and omissions excepted, and subject to technical changes. Our general terms of delivery and payment are applied.